

1

2

3

4

A

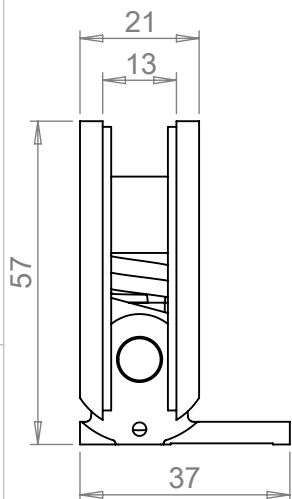

Position d'équilibre réglable
Adjustable balance position
Nullposition einstellbar

Jeu / Gap /
Spiel 2 mm

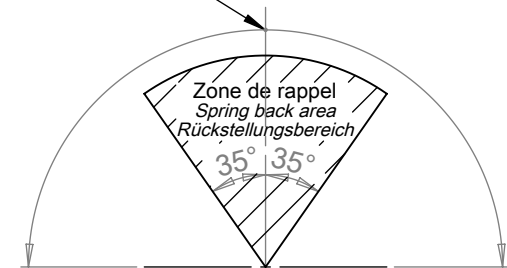

Zone de rappel
Spring back area
Rückstellungsbereich

Vis de réglage de la position de fermeture.
Closure position adjusting screw.
Einstellschraube für die Null-Position

B

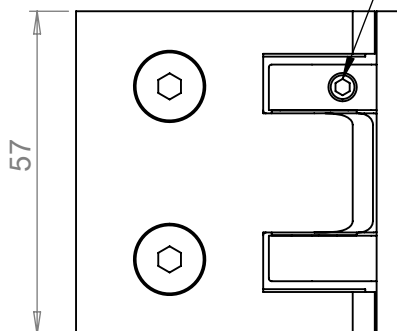
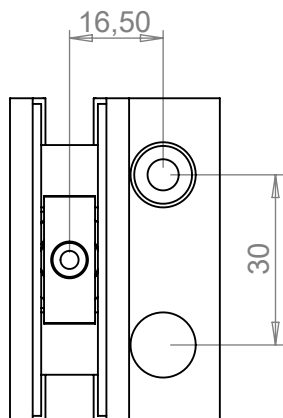

C

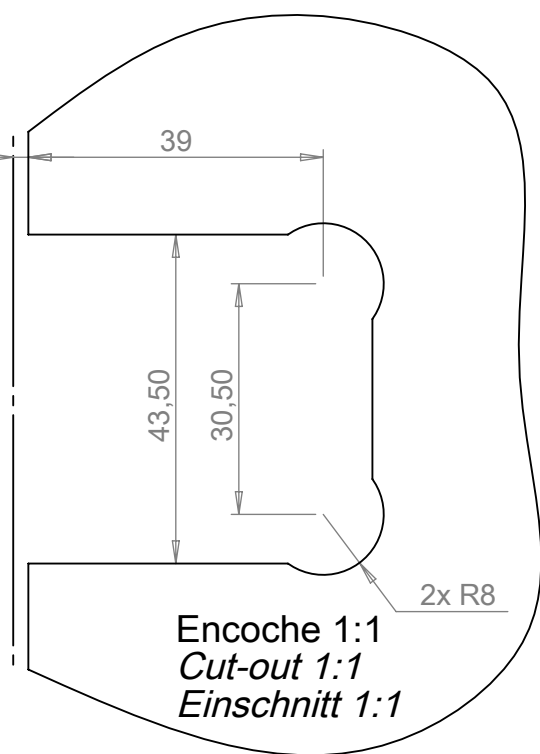

Ou / Or / Oder

D

REVERSI	
Décor Finish Oberfläche	Code article Item Number Referenz-nummer
chromé chromed verchromt	64615K
nickel brossé brushed nickel Edelstahleffekt	64616L
doré gilded vergoldet	64617M
Cales liège incluses Cork shims included Mitgelieferte Kork-Unterlagen	
Ep. glace Glass thickness Glasdicke	Code article Item Number Referenz-nummer
6	09012W
8	09010U
10	09008S
12	

Sur demande
Upon request
Auf Anfrage

Jeu / Gap /
Spiel 5 mm

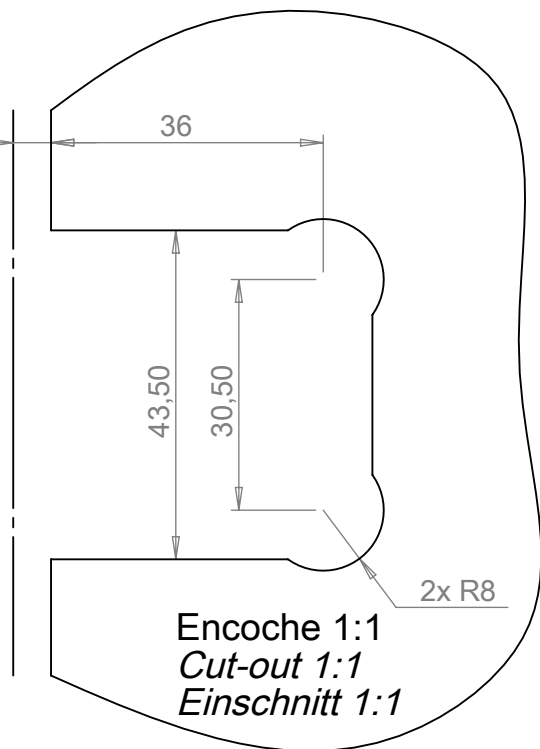
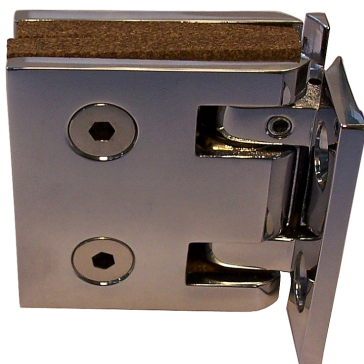

E

Poids de porte admissible par paire 50 Kg
Maximum recommended door weight per pair of hinges 50Kg
Maximal Türgewicht pro Scharnierpaar 50 Kg

F

E

D

C

B

A

Vérif. par :

Plan N° :
64615K
-Com

Charnière REVERSI came isodouche
REVERSI hinge with isodouche cam
Wandscharnier REVERSI mit Nocken isodouche

ADLER
LA TECHNIQUE AU SERVICE DU VERRE

ZA La Barogne, av. des 22 Arpents
77230 Moussy le Neuf
Tél: 01 60 03 62 00; Fax: 01 60 03 62 49

Modifications

Dessiné le :
07/06/12

Ech. :
3:2

Format :
A4

Dessiné par :
C. MARTIN

Vérifié par :

